

CONNECTION DIAGRAM

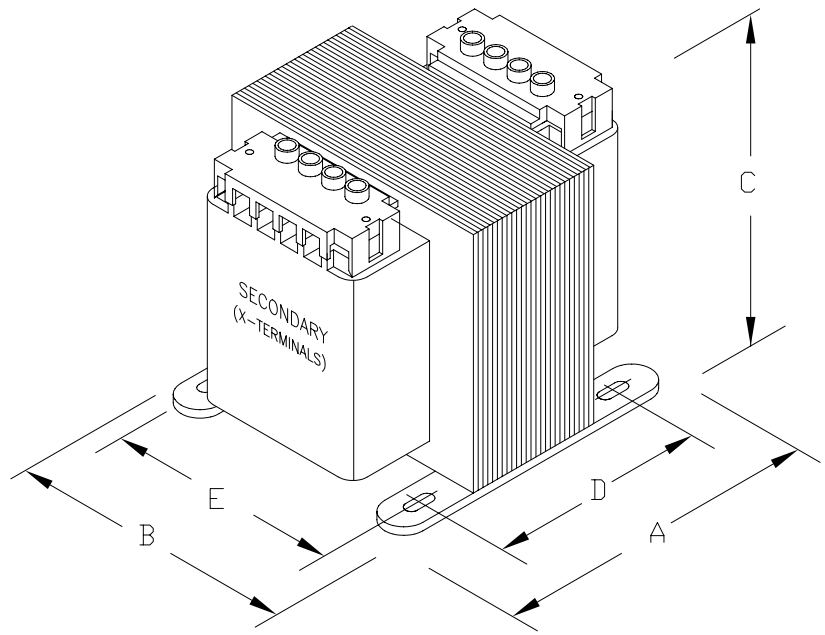

PROVIDED WITH SAFE TOUCH TERMINAL COVERS.  
NO INTEGRAL FUSING CAPABILITY.

DIMENSIONS							APPROX. WT. LBS (KG)
	A	B	C	D	E	MTG. SLOTS	
INCHES (MM)	3.75 (95)	4.50 (114)	4.00 (102)	3.00 (76)	3.75 (95)	0.203X0.460 (5.1X11.7)	



CAT. NO. <b>M200-2045-GAF</b>		CONST. <b>ENCAPSULATED</b>		LISTED  CERTIFIED  IEC 61558	
		MODEL <b>GLOBALTRAN</b>			
<b>RATING</b>					
OUTPUT AMPS	1.74	PRIMARY V	550/575/600	TEMP. CLASS	HZ 50/60
VA	200	SECONDARY V	110/115/120	130°C	REVISION <b>G</b>